

# Experimental Observations and Modelling of Window Glass Breakage in Building Fires

**Y HE**

Center for Environmental Safety and Risk Engineering  
Victoria University of Technology  
14428 MCMC, Melbourne, VIC 8001, Australia

**L POON**

BHP Research-Melbourne Laboratories  
245-273 Wellington Road, Mulgrave, VIC 3170, Australia

## ABSTRACT

The behaviour of glazed windows were investigated in a series of flashover fire experiments conducted in a full-scale multi-storey building. Glass cracking and dislodgement processes were monitored during the experiment. A simple transient heat transfer model was established to estimate window glass temperature and the time of fracture under enclosure fire conditions. The model is incorporated into a fire growth model NRCC-VUT and an external fire spread model ExSpread to predict the effect of fire growth on window glass breaking and the time for external fire spread to occur via external windows respectively. The fire growth model was compared against the result of one experiment in which the glass window was allowed to disintegrate naturally. In this test, the period from initial cracking to complete dislodgment took 160 s. Hence, although it may be possible to predict the onset of cracking, the time for complete dislodgment to occur is not insignificant and not readily predictable. Accordingly, the refinement in the use of a heat transfer model for predicting glass breakage may not necessarily improve the predictions of room fire behaviour over the relatively simple room temperature approach for glass dislodgment. The failure of the external glass window located at the level above the fire enclosure were recorded in all four tests and were simulated with the external flame spread model. It was observed that following the initial dislodgment, there was a further delay of 1-4 minutes before complete dislodgment took place. A relatively high averaged glass failure temperature of 500 K was used in the model to allow for window dislodgment to occur. The model predicts the time of initial dislodgment reasonably well but conservatively assumes that it corresponded to complete dislodgment for the purpose of predicting time for flame spread via radiation from an external plume.

**KEY WORDS:** cracking, dislodgment, fire growth, glass fracture, temperature, transient.

## NOMENCLATURE

$A$  - vent opening area ( $m^2$ ).

$E$  - emissive power per unit wavelength  
( $W/m^2 \mu m$ );

Young's Modulus.

$H$  - height of the opening (m).

$h$  - heat transfer coefficient ( $W/m^2 K$ ).

$k$  - thermal conductivity ( $W/m K$ ).

$q$  - heat transfer rate ( $W/m^2$ ).

$T$  - temperature (K).

$t$  - time (sec).

$w$  - width of the opening (m).

$x$  -  $x$  dimension (m).

$\beta$  - linear expansion coefficient.

$\epsilon$  - emissivity.

$\lambda$  - wavelength ( $\mu m$ ).

$\sigma$  - Stefan-Boltzmann constant.

$\sigma_y$  - normal failure stress (Pa).

### Subscripts

d - door.

e - equivalent.

g - glass.

i - inner.

o - outer.

s - surface.

w - window.

## INTRODUCTION

The fracture of window glass has been identified as an important phenomena in building fires. Glass is a commonly used material in building construction. It is also a very fragile material. When a fire occurs in a building, the room which encloses the fire initially acts as a fire barrier. This barrier often incorporates glass in windows and doors. The barrier prevents fire and toxic smoke spreading to adjacent rooms and the rest of the building and hence provide crucial time for building occupants to evacuate to safety. However, as the fire grows in the enclosure, the heat generated from the combustion will cause damage to the window, and eventually complete dislodgment of the glass may occur. The broken windows and doors will then create openings for fire and smoke to spread to the rest of the building. Fire induced flow will help supply fresh air into the burn room through the openings. This will assist the fire to develop into what is called a flashover condition. It is this type of fire that causes significant life and property losses.

The broken windows on both the level of fire origin and the levels above will provide means for flame smoke to spread externally to other parts of a building or even to other buildings adjacent to the building on fire, causing extended damages. Fire spread through external passages has been investigated in the past [1]. However, the behaviour of window glass which can be regarded as a fire barrier and the modelling of the process of glass breaking in fires have received inadequate attention. Attempt is made in this study to incorporate a transient heat transfer model into a fire growth model and an external smoke spread model to estimate times of window fracture and its effect on fire growth and smoke spread in multi-storey compartment buildings.

The stresses that cause window glass to break in fires are attributed to mechanical forces (pressure difference between an enclosure and the outside) and thermal expansion. Among these two factors, the latter is dominant, since thermal stress is usually orders of magnitudes greater than mechanical stress in case of fires. It is, therefore, sufficient to analyse thermal stress in the study of window glass breakage in fires [2].

Theoretical and numerical analyses have attributed the initial cracking of window glass to the temperature difference between shaded and unshaded regions of the glass [3,4]. A generalised expression for thermally induced stress at the edge of the glass pane is

$$\sigma_y = E\beta\Delta T, \quad (1)$$

where  $\sigma_y$  is the normal failure stress,  $E$  is Young's Modulus,  $\beta$  is the coefficient of linear expansion, and  $\Delta T$  is the temperature difference between the heated glass and the insulated edge. For soda-lime glass, a value of 80 °C for the breakpoint temperature difference can be worked out from its mechanical and thermal properties [5]. Experiments, in which glass surface temperatures were measured have been conducted by Skelly *et al* [6] to test the results of theoretical and numerical analyses. Their experiments revealed a large variation in breakpoint temperatures (61 °C - 132 °C).

The strength of glass is greatly reduced by flaws in the glass, such as surface and volume flaws, pitches and bubbles. The flaws amplify the stresses in their neighbourhood by many orders such that the local stress may exceed the molecular strength even though the average stress is still well below the critical value [7]. The deterministic approach to calculate glass fracture demands the knowledge of the data on the distribution (location), dimension and orientation of flaws, as well as the variation of physical properties due to impurity and thermal treatment processes during manufacturing [8]. However, in reality such information is not available nor is it tractable to model. The breakpoint temperature variation range in the experiment by Skelly *et al* simply reflected the high degree of uncertainties in these parameters. Other influential factors may include low frequency pressure fluctuation in the burn room caused by the pulsation behaviour of the flame and unsteady movement of air.

The window glass temperature in a fire environment is determined by the heat transfer process from the fire to the glass. Conventional modelling approach by-passes the analysis of convective, conductive and radiant heat transfer and correlates, as the first order approximation, the glass fracture with the hot layer gas temperature in the room [9,10]. It may be a concern that such an approach sacrifices the accuracy in the predicted time of fracture as a trade-off for calculation efficiency.

In the present study, a transient heat transfer model is incorporated into the NRCC-VUT fire growth model and an external fire spread model to estimate the surface temperature and time of fracture of window glass in building fires. The method of estimating glass fracture in room fires based on glass temperature prediction is compared against the conventional room temperature correlation approach. The predictions of the models for a set of flashover fire experiments are presented and discussed.

## THE MODELLING OF GLASS FRACTURE IN FIRES

Glass is a semi-transparent solid material. Radiant energy is absorbed, emitted and transmitted along the optical path of such material. Modelling heat transfer in a semi-transparent material is more involved than in an opaque material. Heat transfer through convection, conduction and radiation and heat absorption have to be considered (Fig. 1). To complicate the matter

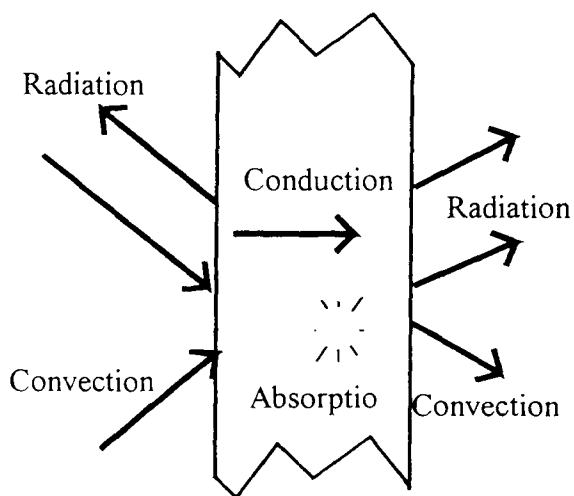

Fig. 1. Heat transfer through glass.

further, the transmittance of normal window glass (e.g. soda-ash glass) is wavelength, radiation intensity and temperature dependent [11, 12]. Sincaglia and Barnett [13] provided a detailed analysis of radiation heat transfer in window glass and developed a relatively sophisticated one-dimensional heat transfer model to predict temperature distribution inside the glass exposed to a radiant heat source. Their model produced excellent agreement with experimental results of glass surface temperature and time of fracture with a relative error of 3.2%. Their experiments were conducted in a compartment with burning liquid hexane as heat release source. However, it is not known whether the model has been verified against realistic transient fires.

Although window glass is semi-transparent to a wide band of thermal radiation frequency, it is almost opaque to radiation waves whose wavelengths are greater than 2.5  $\mu\text{m}$  [14]. Fortunately, a great proportion of thermal energy is radiated at the long wavelength range in building fire environments. The gas and soot mixture in the burn room can be treated as gray body whose thermal radiation spectrum is similar to that of a black body [15]. Examination of black and grey body emissive power spectrum at  $T=1,000$  K reveals that almost 80% of the total energy is radiated at wavelengths greater than 2.5  $\mu\text{m}$ . Therefore, in dealing with thermal radiation in building fires, window glass can be approximated as a gray body. This approximation should yield conservative outcome for predicting glass fracture, since more energy is absorbed by a gray body than a semi-transparent material. In the present study, the window glass is treated as a wall which is opaque to thermal radiation. Radiative, convective and conductive heat transfer are included in the analysis of non-steady state heat transfer.

## ALGORITHM

Heat transfer through window glass is modelled as a one-dimensional problem. The heat transfer rates at the two surfaces of the glass slab include radiation and convection terms

$$q = h(T - T_{gs}) + \sigma(\varepsilon T^4 - \varepsilon_g T_{gs}^4). \quad (2)$$

Since window glass has a relatively large thermal diffusivity and usually small dimension along the direction of conduction, it is treated as a thermally thin material and is divided into 20 element slabs for conduction calculations. This division is sufficient for the equation solver to reach the converged solutions with minimal cost of CPU time of the program. The heat conduction equation is expressed as

$$\frac{\partial T_g}{\partial t} = k \frac{\partial^2 T_g}{\partial x^2}, \quad (3)$$

with the boundary conditions

$$\left. \frac{\partial T_g}{\partial x} \right|_{x=0} = -\frac{q_i}{k} \quad \text{and} \quad \left. \frac{\partial T_g}{\partial x} \right|_{x=L} = -\frac{q_o}{k}, \quad (4)$$

where  $L$  is the thickness of the glass, subscripts  $i$  and  $o$  denote the inner and outer surfaces respectively.

A computation routine which is used in the NRCC-VUT fire growth model to solve the heat conduction equation for wall temperature distribution is used to compute the unshaded window glass temperature. The NRCC-VUT fire growth model is a modified version of the NRCC fire growth model which was initially developed by researchers at the National Research Council of Canada (NRCC) [10]. The latter is a simplified one-zone model for single room fires. It treats the fire room as a well stirred combustion chamber and assumes uniformly distributed properties inside the room. The fuel burning rate in this model is coupled with the conditions in the fire room. The NRCC fire growth model has been verified against the three types of fire scenarios, namely, smouldering, flaming and flashover [16]. Substantial modifications to the model have been undertaken at Victoria University of Technology to achieve closer agreement between the predicted and the measured results [17].

The criterion for glass fracture in the model was the rise of glass temperature in the unshaded region by 80  $^{\circ}\text{C}$ . The window failure (complete dislodgement) was actually modeled with the

traditional average room temperature method. The window failure criterion of the traditional method is the room temperature rise and was set at 320 °C in the model.

When a window in the burn room breaks, it creates additional opening area for natural ventilation flows. This phenomenon is handled in the NRCC-VUT model by specifying an enlarged door opening. To render the model applicable to the real window size situation, an equivalent opening area  $A_e$  is introduced for the calculation of vent flows to and out of the burn room after the window breaks. This equivalent opening area is equal to the total area of the door  $A_d$  and window  $A_w$  and is assigned a height equal to the standard door height. The smoke mass flow rate through the door is estimated as

$$m_d = m_e(1 - A_w/A_e) , \quad (5)$$

where  $m_e$  is the mass flow rate through the equivalent opening.

The one-dimensional heat transfer algorithm has also been employed in another model which has been developed to predict the time of external flame spread via external windows [18]. The model predicts the time of glass failure of the window located on the level above the fire enclosure. The model, called ExSpread, determines the development of an external window plume when flashover occurs and burning becomes ventilation controlled. The window of the fire enclosure is considered to have been completely dislodged when this happens. The size of flames emerging from an opening of a burning enclosure is defined as the size of the luminous region whose boundary is characterised by the completion of combustion. This corresponds

to a temperature rise of about 500°C above ambient. Figure 2 schematically depicts the locations of the windows on two levels and the plume outside. The projection of flames from an opening in a burning enclosure is calculated from the empirical relationship developed by Thomas and Law [19]. The temperature of the glazing above the broken window of the room of fire origin is then determined based on the imposed heat flux from the visible portion of the plume. The time of failure of the glazing on the upper level window is estimated according to a temperature criterion. The model simplifies the prediction of glass failure process by assuming that glass dislodgement corresponds to the cracking and by avoiding the untraceable falling history of individual pieces of glass [20]. A relatively high temperature of 500°K was therefore employed as the criterion for glass failure.

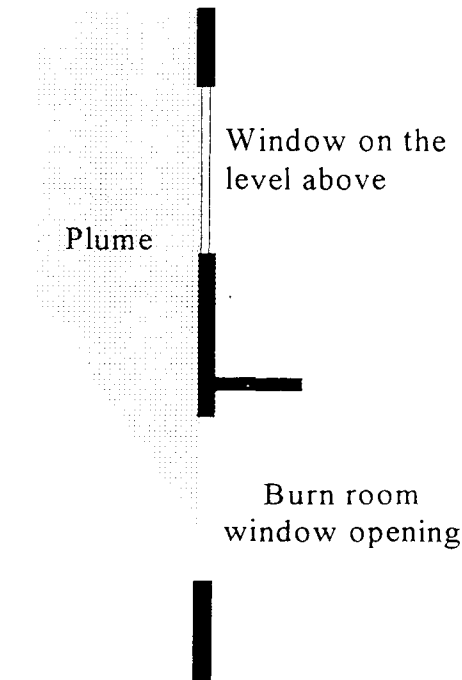
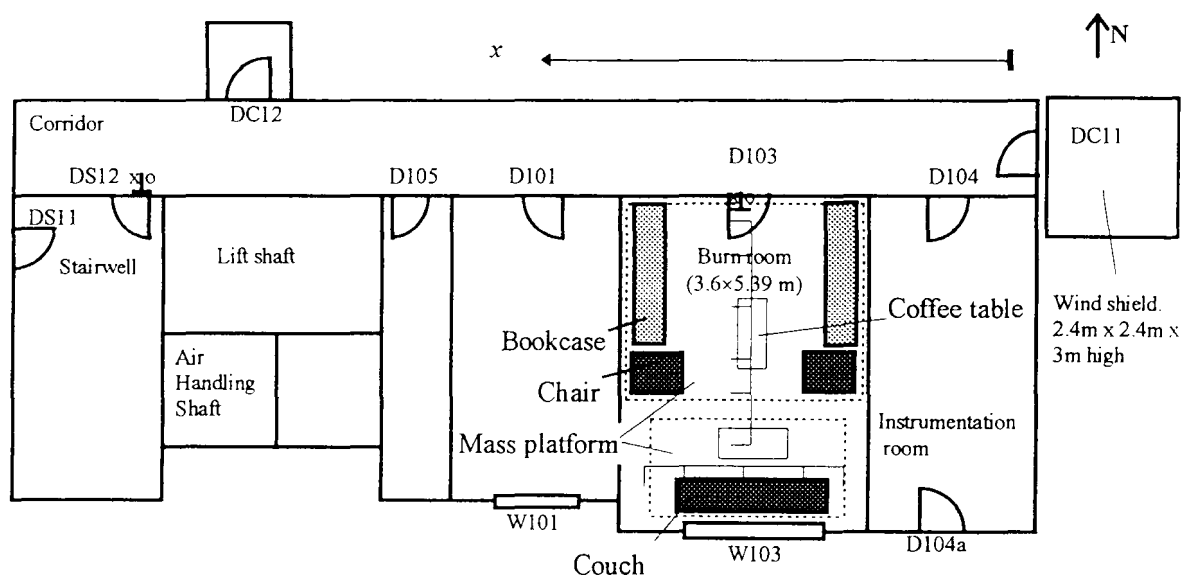

Fig. 2. Projection of flame from an external window.

## EXPERIMENT

A set of four experiments were conducted to study the phenomena of window breaking and external fire spread. The experiments were carried out in a full-scale prototype building which has four stories connected by a lift shaft, a stairwell and air handling shafts. Figure 3 is a schema of the first floor on which the fire source was located. The layout of the other levels, except for Level 4, are similar to Level 1. Level 4 consisted of a corridor only. Room 103 on the first floor was used as the burn room which has a size of 5.39×3.69×2.4 m high. The burn room was connected to the first floor corridor (15.6 m long, 1.4 m wide and 2.57 m high) through a door opening of standard size (0.8×2.0 m) located on the north face of the room. Opposite this door was a 2.4×1.5 m high window in a standard three-pane configuration (2 small sliding panels 3 mm thick and one fixed glass sheet 4 mm thick). The window construction is shown in Fig. 4. It was located in the centre of the south wall, 500 mm above the floor (refer to Fig. 5). The window was constructed using timber reveals and consists of an all-aluminium frame. The window was mounted on a steel frame which could be pulled down to simulate an abrupt shattering of the glass.



Key: ⊥ Thermocouple; × Gas sample point; ○ McCaffrey cup;

**Fig. 3** Instrumentation and layout on Level 1 of the Experimental Building-Fire Facility.

A weighing system was constructed to record the mass loss of fuel on two floor platforms during the experiments. Two matrices of thermocouples were placed vertically in the burn room, one in the north-south direction and the other in the east-west direction. There were 35 thermocouples distributed on each of these racks. The lowest thermocouple was 250 mm above the floor. Four thermocouples were mounted on the inner surface of the centre pane of the window (Fig. 4).

Another thermocouple was also mounted on the centre pane but it was stretched 100 mm away from the glass inner surface and 300 mm below the upper frame. An array of eight evenly spaced thermocouples was placed along the vertical centre line of the burn room door. Also located at the burn room door (D103) were eight gas sampling probes and eight velocity probes (McCaffrey cups) alongside the thermocouple array.

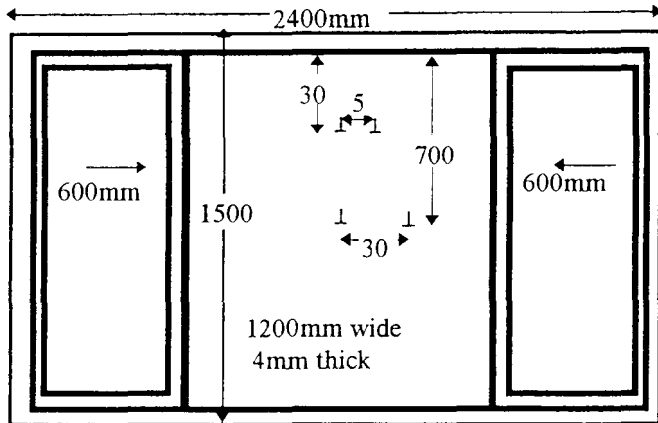

Fig. 4 The burn room window construction.

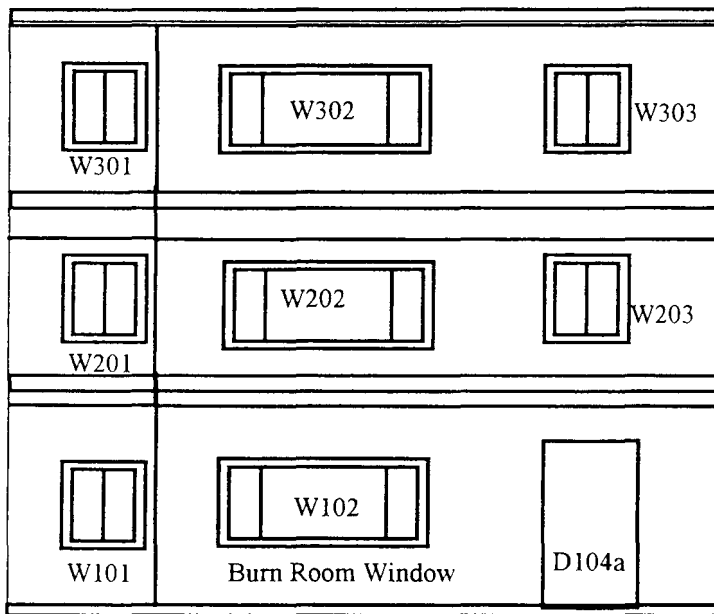

Fig. 5. The external facade (south side) of the building.

The burn room window and the windows above the level of fire origin on the southern facade of the building are shown in Fig. 5. Instruments were also installed in the first floor corridor, stairwell and other levels of the building. However, only the experimental results from the burn room and the window conditions are reported in this paper.

The fuel configuration in the burn room is illustrated in Fig. 3. The fuel load consisted of a three-seat couch, two single-seat sofa, two coffee tables, and two book shelves with stacks of books. The couch and one coffee table were located on the small platform, the others were on the large platform. The fire was ignited in the centre of the couch with a 150 g wood crib.

The four experiments conducted are denoted as FO1, FO2, FO3 and FO4. In the first three experiments, the burn room window was lowered at times corresponding to the inside glass surface temperature reaching 250 °C to simulate an abrupt glass shattering process. Table 1 lists the ventilation, fuel load and the window lowering time of each experiment. The fuel load configurations in the four experiments were identical. All other doors which are not specified in Table 1 were closed during the experiments.

Table 1. Summary of flashover fire tests conditions

Test ID	Burn room door (D103)	Stairwell door (DS12)	Fuel mass (wood equivalent) (kg)	Window lowering time after ignition (min:sec)
FO1	Open	Closed	566	5:25
FO2	Closed	Closed	568	9:50
FO3	Closed	Closed	569	9:35
FO4	Open	Open	567	Not lowered

## EXPERIMENTAL RESULTS AND COMPARISON WITH MODEL PREDICTIONS

The fire experiment FO4 was the only experiment that involved natural window fracture process in the burn room. Therefore, only this experiment was simulated with the NRCC VUT fire growth model. However, all the experiments were simulated with the ExSpr model to estimate the time of window failure on the level above the room of fire origin.

### Glass Fracture In the Burn Room Window

The results of heat release rate and burn room average temperature are presented in Fig. 6 together with the quantities measured in the experiment. It is seen from the figure that the heat release rate and average room temperature were well predicted by the model, although oxygen concentration was over-estimated. The temporary stagnation in the measured room temperature and the temporary drop in the predicted room temperature resulted from

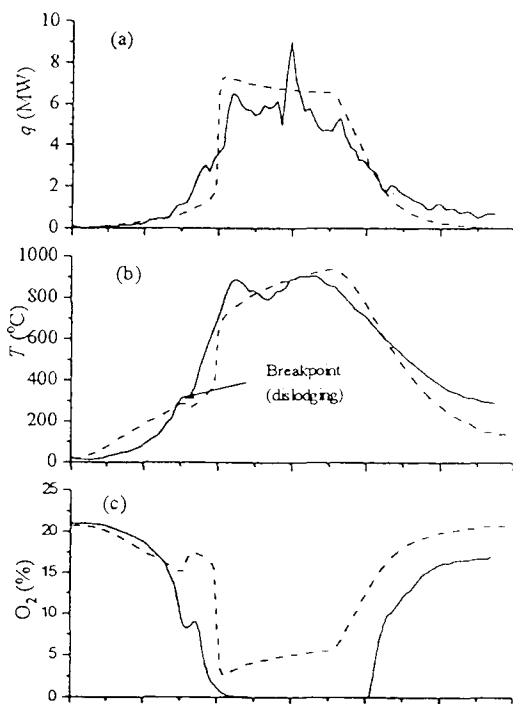
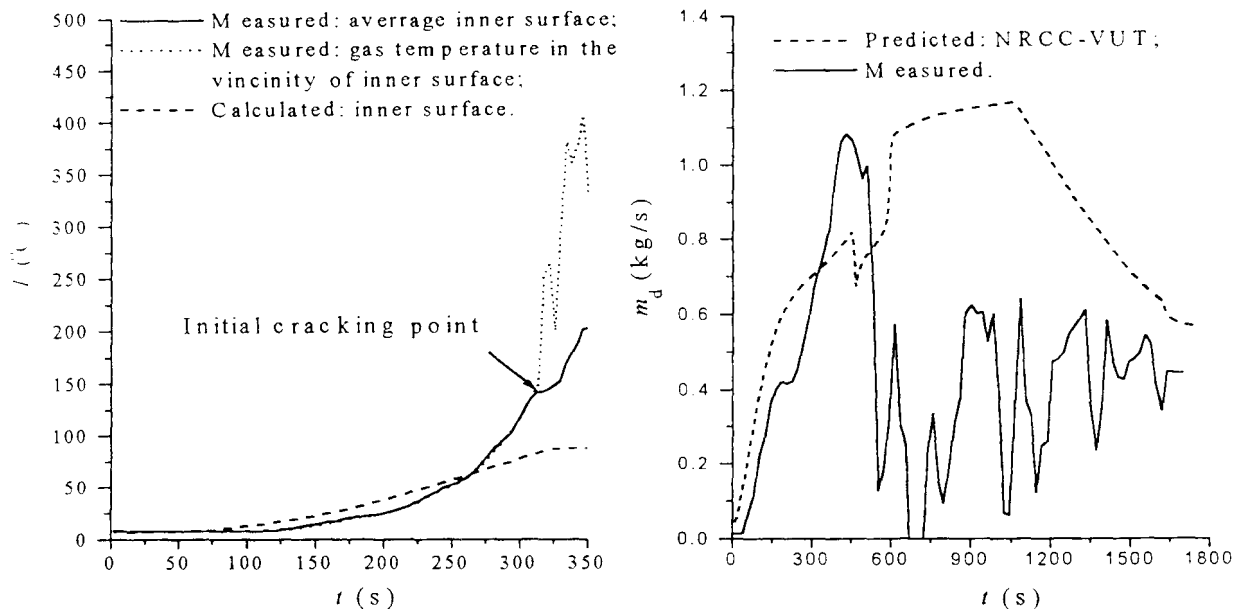

**Fig. 6.** Predicted and measured results of flashover fire FO4.

(a) Heat release rate; (b) Average room temperature; (c) Oxygen concentration

the breaking of the glass window. There were also noticeable changes in the measured and predicted oxygen concentrations in the burn room following the window breakage. The predicted temperature and oxygen concentration in the burn room are presented in Fig. 6(b) and (c). When the glass broke at the average room temperature of 320 °C, cool fresh air entered the burn room. The average room temperature experienced a temporary drop. The fresh air enriched the oxygen concentration in the room. The fire spread over the fuel surface accelerated and the fuel burning rate increased. As a result, the room temperature and carbon monoxide concentration regained the climbing trend at about 450 s. The average temperature from the four thermocouples mounted on the inner surface of the window glass and the predicted glass inner surface temperature are presented in Fig. 7. Also included is the gas temperature measured at a distance of 100 mm away from the glass inner surface and 700 mm below the ceiling. It is seen from Fig. 7(a) that the measured inner surface temperature reached the breakpoint at about 315 s after the ignition whereas the predicted breakpoint is at 325 s. The conventional room temperature correlation method in the original NRCC-VUT model predicted a time of window fracture at 455 s [see Fig. 6(b)]. On the other hand, the video record of the experiment indicated an initial cracking of the window at 315 s and the complete dislodgment at about 475 s. The calculation for the glass temperature terminated once its temperature reaches the breakpoint, hence the glass temperatures in Fig. 7(a) remain constant after the breakpoint.





**Fig. 7.** Comparison of the measured and predicted (a) window glass temperatures and (b) smoke exhaustion rates through the burn room door.

The breaking of a glass window in a realistic enclosure fire is a gradual process [16, 20]. Video evidence of this particular experiment revealed that with the increase of room temperature, there was an initial cracking around the edge or corner of the window, then followed by the dislodgment of part of the glass pane, creating a small opening in the window. Hot smoke was exhausted from the opening and the rate of increase of room temperature is reduced. As the temperature increased further, the opening was enlarged and more fresh air entered into the room, promoting the combustion process and a more rapid increase in temperature. Generally, the critical event in a building fire is the dislodgment of window glass which leads to the flashover condition. The initial cracking, or fracturing, does not allow sufficient air to flow into the burn room and to sustain the fire growth. Therefore, initial cracking should be distinguished from dislodgment. Present computer models predict the onset of cracking rather than the dislodgment process. Or in other words, the models coincides the initial cracking with the total dislodgment.

The measured glass inner surface temperature is seen to be about 55  $^{\circ}\text{C}$  greater than the predicted value at the time of breakpoint. The former is also seen to coincide with the gas temperature in the vicinity of the glass. This raises doubts on the accuracy of the temperature measurement with the thermocouple mounting technique used. The measurement of glass surface temperature is known to be delicate and difficult task [21]. It is believed that because the thermal properties of thermocouple wires are quite different from that of glass, significant measurement errors may creep in. However, detailed discussion on the improvement of temperature measurement on glass surface is beyond the scope of this paper.

The measured velocity and temperature (hence density) profiles were integrated over the upper part of the burn room door from the neutral plane to the upper edge of the opening to obtain the vent flow rate exhausted to the adjacent corridor. The result is compared with the NRCC-VUT prediction in Fig. 7(b). Reasonably good agreement is seen between the two results for the initial period. After the window was fractured, the vent flow rate was strongly influenced by the external wind and exhibited large fluctuations.

## Glass Failure in the External Upper Level Window

Glass temperature on the upper level window was not measured. However, observations of the times of glass fracture and dislodgement were made. Results of these times are shown in Table 2. Also shown in Table 2 are the times predicted by the ExSpread model for the glass to fail (i.e. dislodged sufficiently for unimpeded radiation to initiate ignition of exposed combustibles).

**Table 2.** Observed and predicted times of events during experiments.

Observation	FO1	FO2	FO3	FO4
Initial crack in W102	4:40	4:40	4:55	5:15
Flashover	7:20	14:20	13:00	9:00
<i>Initial dislodgement of W202</i>	<i>16:10</i>	<i>18:05</i>	<i>13:20</i>	<i>11:05</i>
More dislodgement of W202	n/a	18:25	15:20	12:40
Glass fully dislodged from W202	n/a	20:50	17:15	n/a
<i>ExSpread predictions</i>	<i>11:37</i>	<i>16:02</i>	<i>14:11</i>	<i>10:54</i>

Note: Times are in min:secs, n/a: not available.

The external plume used in the model is a function of the burning rate in the enclosure. Because of this relationship, the timing of glass failures is closely associated with the history of the burning rate. Failure of the upper level window was therefore found to occur following flashover of the fire enclosure on the level below. As would be expected, the times of failure correlated well with high peaks of burning rates, indicating that large amounts of unburnt volatiles are forced out of the burn room window to form a tall burning plume. However, a lag of a few minutes usually occur following flashover before this peak occurred.

Apart from test FO1, the external glass failure time predictions corresponding to the initial dislodgement are quite reasonable. Following initial dislodgement, there is a further 1-4 minutes before the glass completely dislodged. However, for the purpose of predicting time of spread via radiation, the glazing may be conservatively considered to have completely dislodged at the time of its initial dislodgement.

The early prediction failure time for test FO1 is caused by a spike in the burning rate data towards the 12 minute mark (see Fig. 8). At this time, flames were observed to reach approximately 1.7 m above the window opening. This means that the visible flame tip extended about 0.5 m above the sill of the window on the level above. It is therefore plausible that the flames could have damaged the glass of window W202, although the observations did not indicate this. In addition, the extremely high peaks of burning rate that were recorded may also be questionable. If this test result is ignored, then the model predicts the time of glazing failure reasonably well for the purpose of predicting flame spread through the broken window.

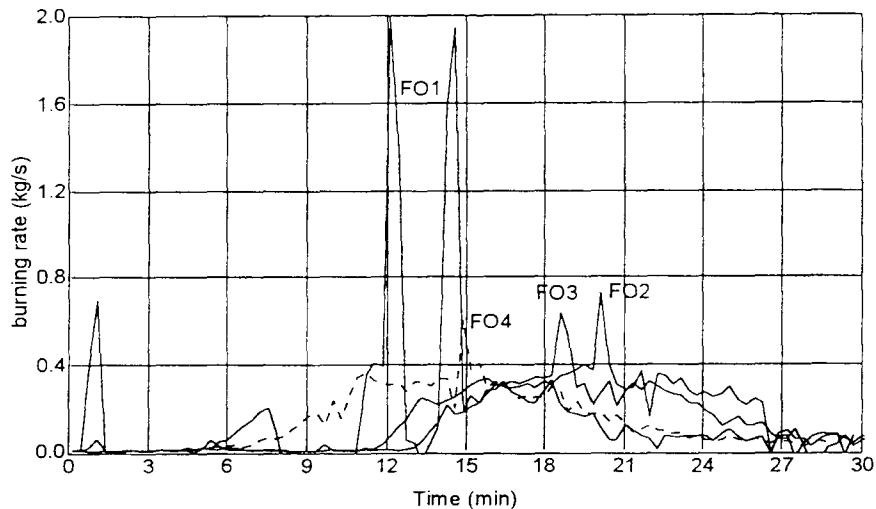

**Fig. 8.** Burning rates for Test FO1 to FO4.

## CONCLUSION AND RECOMMENDATION

A numerical computation routine has been incorporated into a fire growth model and an external smoke spread model to calculate temperature distribution in window glass in the room of fire origin and on the level above. This routine is based on a non-steady state heat transfer analysis. Equipped with this routine, the models are able to predict the time of window fracture and hence the effects on fire growth and smoke spread via external means. For the given breakpoint criteria, the models produced reasonable predictions of window fracture times, though discrepancy existed between the measured and predicted glass surface temperature, which is attributable to the errors in the temperature measurement.

The breaking of glass windows in real enclosure fires is a gradual process from initial cracking to complete dislodgment. The computation of such a process is not presently tractable. However, such a process may be reasonably simulated as an abrupt event using an indicative time correlated to the averaged room temperature or to the glass temperature beyond the point of initial cracking to reflect the onset of the event.

The phenomenon of window breaking and dislodging in fires may be influenced by a cluster of physical parameters such as the external force (pressure), the non-homogeneous distribution of physical properties in the glass, the framing construction and the fire itself. It is unlikely that all of these can be realistically modelled. From view points of required simplicity, accuracy, efficiency and conservatism, the conventional average temperature correlation approach for predicting window glass breaking is considered preferable.

## ACKNOWLEDGMENT

This work was supported by an ARC Collaborative Research Grant and Fire Code Reform Centre Ltd., Australia. The project was coordinated by Prof. Vaughan Beck, the Director of the Centre for Environmental Safety and Risk Engineering. The collaboration between Victoria University of Technology and the Fire Research Laboratory, National Council of Canada is gratefully acknowledged.

## REFERENCES

- 1 Read R. E. H., 1991, "External Fire Spread: Building Separation and Boundary Distances," Building Research Establishment Report, Fire Research Station, Building Research Establishment, Borehamwood, Herts, WD6 2BL, U.K.
- 2 Emmons, H. W., 1986, "The Needed Fire Science", *Fire Safety Science - Proceedings of the First International Symposium*, eds. C. E. Grant and P. J. Pagni, Hemisphere, Washington, D.C., pp.33-53.
- 3 Hassani, S. K. S., Shields, T. J. and Silcock, G. W., 1995, "Thermal Fracture of Window Glazing: Performance of Glazing in Fire", *J. Applied Fire Science*, Vol 4(4), pp.249-263.
- 4 Joshi, A. A and Pagni, P. J., 1994, "Fire-Induced Thermal Fields in Window Glass. I - Theory", *Fire Safety Journal*, 22, pp.25-43.
- 5 Holloway, D. G., *The Physical Properties of Glass*, Wykeham Publications, London, 1993.
- 6 Skelly, M. J. and Roby, R. J., 1991, "An Experimental Investigation of Glass Breakage in Compartment Fires", *J. of Fire Prot. Engr.*, 3(1), pp.25-34.
- 7 Tada, H., Paris, P. C. and Irwin, G. R., 1985, *The Stress Analysis of Cracks Handbook*, 2<sup>nd</sup> ed., Paris Productions, Inc.
- 8 Doremus, R. H., 1994, *Glass Science*, 2<sup>nd</sup> ed., John Wiley & Sons Inc., New York.
- 9 Milner, H. E. and Rockett, J. A., 1987, "User's Guide to *FIRST*, A Comprehensive Single-Room Fire Model", Report No. 87-3595, p124, National Institute of Standards and Technology, Gaithersburg, MD, USA.
- 10 Takeda, H. and D. Yung, 1992, "Simplified Fire Growth Models for Risk-Cost Assessment in Apartment Buildings," *J. Fire Prot. Engr.*, 4(2), pp.53-66.
- 11 Siegel, R. and Howell, J. R., *Thermal Radiation Heat Transfer*, 3rd Ed., Hemisphere Publishing Corporation, Washington, 1992.
- 12 Bach, H. and Neuroth, N., Eds., 1995, *The Properties of Optical Glass*, Springer-Verlag, Berlin.
- 13 Sincaglia, P. E. and Barnett, J. R., 1997, "Development of a Glass Window Fracture Model for Zone Type Computer Fire Codes", *J. of Fire Prot. Engr.*, 8(3), pp.1-18.
- 14 Bach, H. and Neuroth, N., Eds., 1995, *The Properties of Optical Glass*, Springer-Verlag, Berlin.
- 15 De Ris, J., 1979, "Fire Radiation – A Review", *Seventeenth Symp. (Int.) on Comb.*, The Combustion Institute, Pittsburg, pp.1003-1016.
- 16 Beck, V., He, Y., and Luo, M., 1995, "Experimental Validation of the NRCC Fire Growth Model," CESARE Report 95-01, July 1995, Centre for Environmental Safety and Risk Engineering, Victoria University of Technology, PO Box 14428, MCMC, Melbourne 8001, Australia.
- 17 He, Y., 1996, "A Simple Radiation Heat Transfer Model for Prediction of Fire Growth," *Proceedings of the Sixth Australian Heat and Mass Transfer Conference*, Australian Fluid and Thermal Engineering Society, Sydney, 9-12, December (in press).
- 18 Poon, S.L., "Modelling Time of Fire Spread via External Windows", Fire Code Reform Centre Project 4, BHP Research Report No. BHPR/R/1997/003, August 1997.
- 20 Thomas, P. H. and Law, M. (1972). 'The projection of flames from burning buildings' *Fire Research Note, No. 921*.
- 21 Silcock, G. W. and Shields, T. J., 1993, "An Experimental Evaluation of Glazing in Compartment Fires," *Proceedings of Interflam '93*, pp.747-757.